

General Information

The Teccor SIDACtor is a solid state transient voltage protector designed for use in telephony, data, and some AC applications.

The SIDACtor is a bidirectional device that is normally connected to the high side of a circuit and a common. The SIDACtor remains in a high off-state impedance (leakage current $<5\mu\text{A}$) until it senses a voltage exceeding its voltage breakover (V_{BO}). Upon sensing an overvoltage, the SIDACtor will clamp the voltage and transition through a positive or negative zener region until enough current is present to allow the device to crowbar into a low impedance state. The typical voltage drop across the device during full conduction is typically less than 5 volts. The SIDACtor will return to its high impedance state when the current is interrupted or falls below the minimum holding current of the device.

SIDACtor performance does not degrade with time, bias, number of operations or surges within the devices *Peak Pulse Current* rating. It should be noted that the SIDACtor will fail short if the device is subjected to a surge that exceeds its rated *Peak Pulse Current* (I_{PP}) or *Peak One Cycle Surge Current* (I_{TSM}).

SIDACtors are available in breakdown voltages ranging from 30 to 540 volts and Peak Pulse Current ratings up to 500 amps ($2 \times 10\mu\text{S}$). Tape-and-reel packaging is available for the TO-92 and TO-220 packages along with embossed carrier reel packing for the DO-214AA.

Please consult the factory for more information.

Features

- Bidirectional Transient Voltage Protection
- Breakover Voltages from 27 - 540 Volts
- Patented Multi chip packages
- Robust Surge Current Capabilities
- ION Implant Technology
- Clamping speeds of nanoseconds
- Electrically Isolated Package
- Glass-passivated Junctions

Electrical Parameter Terminology

V_{BO} – Breakover Voltage

V_{BO} (MIN) — Minimum voltage point at which the SIDACtor may begin to conduct

V_{BO} (MAX) — Maximum voltage required to begin conduction

I_{BO} – Breakover Current

Current through the SIDACtor at the breakover point (V_{BO})

I_{PP} – Peak Pulse Current

Maximum rated impulse current

I_{TSM} – Peak One Cycle Surge Current

SIDACtor's maximum one cycle AC surge current rating

I_T – On-state Current

Continuous on-state current rating of the SIDACtor

V_T – On-state Voltage

Voltage drop across the device at rated on-state current

I_H – Holding Current

Minimum current required to maintain the SIDACtor in the on state

C_O – Off-state Capacitance

SIDACtors typical off-state capacitance

di/dt – Critical Rate-of-rise On-state Current

Maximum rated rate-of-rise current

V_F – Forward Voltage

Maximum forward voltage across the P0641SA SIDACtor while in the on state

(See Figure 3C on page 13.)

Ordering Information

Part Number Definition

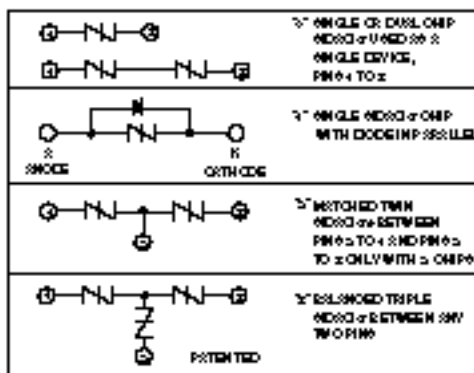
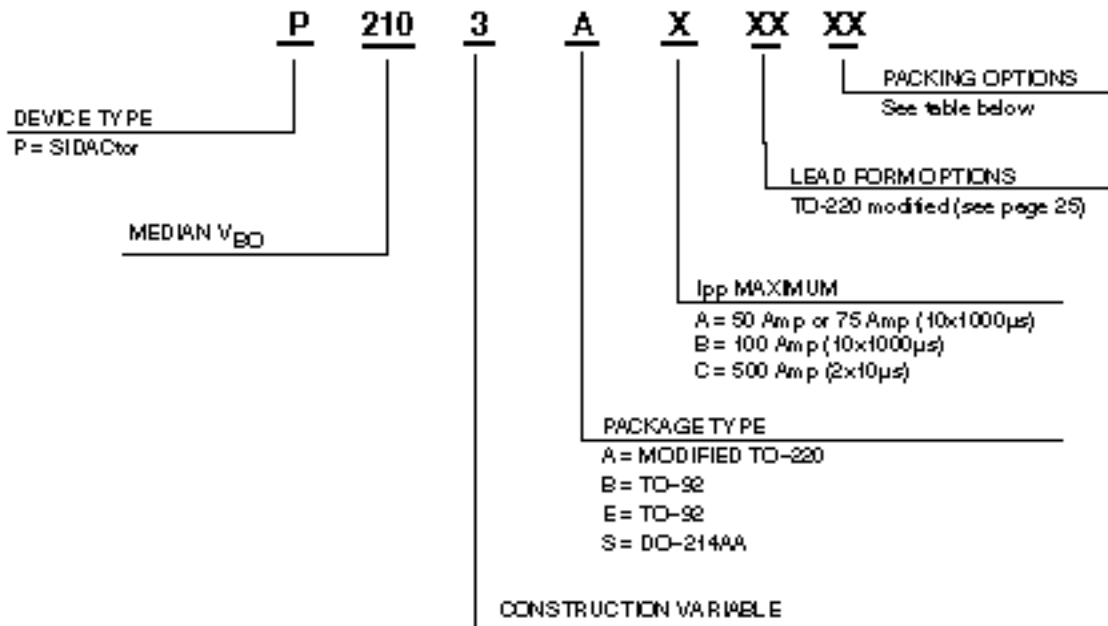

Device Packing Options

Package Type	Description	Packing Quantity	Added Suffix	Optional	Industry Standard
TO-92	Bulk Pack	2000		Standard	None
	Tape and Reel Pack	2000	RP	Option	EIA RS-468-A
	Tape and Ammo Pack	2000	AP	Option	EIA RS-468-A
TO-220	Bulk Pack	500		Standard	None
	Clear Plastic Magazine or Tube Pack	50	TP	Option	None
	Tape and Reel Pack	700	RP	Option	EIA RS-468-A
	Tape and Reel Pack for Type 61 Leadform	700	RP	Option	EIA RS-468-A
DO-214AA	Embossed Carrier Reel Pack	2500	RP	Standard	EIA-481-1
	Bulk Pack	5000		Option	None

Detailed packaging drawings are available from the factory upon request.

*Standard lead spacing is .200" for TO-92 Reel Pack. For other spacing requirements please contact the factory.

Quality Assurance

100% Testing is a constant monitor for Quality Assurance.

Test Description	Condition	Comments
1. Surge (I_{PP})	@ Rated Current	Repeated 2 times in the normal sequence of testing, except for TO-220 which is repeated 4 times.
2. Breakover Voltage (V_{BO})	V_{BO} and absolute peak in forward and reverse directions	All devices fully characterized on voltage to ensure proper operation and reliability
3. Holding Current (I_H)	Measured for a minimum value as rated	This ensures proper delatch (turn-off) after surge current condition.
4. Peak On-State Voltage (V_{TM})	Measured with 1 Amp RMS or DC current	
5. Leakage Current (I_{DRM})	Breakover leakage and off-state leakage	These tests ensure long term reliability.

Electrical Specifications

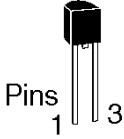
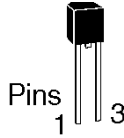
Package Type	Package	Part Number	V _{BO}		I _{BO}	I _{PP}				I _{TSM}	
			Breakover Voltage (Instantaneous Clamping Voltage) (1)(3)(13) Volts		Break-over Current	Peak Pulse Current T _J ≤ 150°C (5) (10)				Peak One Cycle (Sinusoidal) Surge Current (14)	
			PINS 1 to 3		μAmps	Amps				Amps	
			MIN	MAX	MAX	2x10 μs	10x160 μs	10x560 μs	10x1000μs	60Hz	50Hz
E TYPE 70 	Pins 1 3	P0300EA70	27	36	10		100	50	50	30	25
		P0640EA70	58	70	10		150	75	75	30	25
		P0720EA70	65	80	10		150	75	75	30	25
		P0800EA70	75	95	10		150	75	75	30	25
		P1100EA70	90	125	10		100	50	50	30	25
		P1300EA70	120	145	10		100	50	50	30	25
		P1500EA70	140	170	10		100	50	50	30	25
		P2300EA70 (12)	190	265	10		100	50	50	30	25
		P2600EA70 (12)	220	300	10		100	50	50	30	25
		P3100EA70 (12)	275	350	10		100	50	50	30	25
		P3500EA70 (12)	300	400	10		100	50	50	30	25
B TYPE 70 	Pins 1 3	P2300BA70 (12)	190	265	10		150	100	100	60	50
		P2600BA70 (12)	220	300	10		150	100	100	60	50
		P3100BA70 (12)	275	350	10		150	100	100	60	50
		P3500BA70 (12)	300	400	10		150	100	100	60	50
		P1500EC70 (12)	140	170	10	500	200	100	100	60	50

General Notes

- All measurements are made at 60Hz with a resistive load at an ambient temperature of +25°C unless otherwise specified.
- Storage temperature range (T_S) is -65°C to a +150°C.
- The case temperature (T_C) is measured as shown on the dimensional outline drawings. See "Package Dimensions" section.
- Junction temperature range (T_J) is -40°C to +150°C on all devices except for P0300EA70, P0300SA and P0602AA where T_J is -40°C to +125°C.
- The maximum Lead solder temperature (for any soldering process) is +230°C for 10 seconds maximum: ≥ 1/16" (1.59mm) from case.
- All SIDACTors are Bidirectional and all Electrical Parameters apply to both the forward and reverse polarities.
- All SIDACTors are recognized under UL 497B "Protectors for Data Communications and Fire Alarm Circuits", UL File #E133083.

- All SIDACTor Leads are Tin/Lead plated with no less than 5% lead content.
- All SIDACTors meet the surge requirements of the following standards:

CCITT K17 - K20	10/700 μs	1.5 kV
	5/310 μs	38 A
VDE 0433	10/700 μs	2 kV
	5/200 μs	50 A
CNET	0.5/700 μs	1.5 kV
	0.2/310 μs	38 A

Electrical Isolation

Teccor's electrically isolated TO-92 and modified TO-220 SIDACTor will withstand a high potential test of 1600 VAC RMS from leads to case over the operating temperature range.

Electrical Specifications

I_T	I_H	V_T	C_O		di/dt
Continuous On-State DC or RMS Current (6)(15)	Holding Current (2)	Peak On-State Voltage $I_T = 1$ Amp (17)	Off-State Capacitance at 1kHz 1VAC with 50VDC Bias (4)	Off-State Capacitance at 1MHz 15mVAC with 50VDC Bias (4)	Critical Rate of Rise of On-State Current
Amps	mAmps	Volts	pF	pF	Amps/ μ s
MAX	MIN	MAX	TYP	TYP	MAX
1.0	50	5.0	90	90	100
1.0	150	5.0	70	70	100
1.0	150	5.0	70	70	100
1.0	150	5.0	70	70	100
1.0	150	5.0	50	50	100
1.0	150	5.0	45	45	100
1.0	150	5.0	35	35	100
1.0	150	5.0	50	50	100
1.0	150	5.0	40	40	100
1.0	150	5.0	40	40	100
1.0	150	5.0	40	40	100
1.0	150	5.0	50	50	100
1.0	150	5.0	40	40	100
1.0	150	5.0	40	40	100
1.0	150	5.0	40	40	100
1.0	150	5.0	45	45	100

Applications Guide

See Referenced Device Application Notes for Device Recommendations		
Application	Description	Application Note
FCC Part 68	Connection of Terminal Equipment to the Telephone Network	AN1010 AN1011
UL 1459	Telephone Equipment Safety	AN1010 AN1011
Bellcore TR-NWT-001089	Compatibility and Safety for Network Telecommunications Equipment	AN1012
Bellcore TR-NWT-000974	Telecommunications Primary Line Protector Units for Central Office and Station	Call factory for assistance
SLIC	Subscriber Line Interface Circuit	AN1013
PTC	Using PTCs to Pass FCC Part 68 and UL145	AN1020
ISDN	ISDN U & T Interfaces	AN1025
T1	T1 Digital Line Card	AN1023

Electrical Specifications

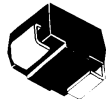
Package Type	Package	Part Number	V _{BO}		I _{BO}	I _{PP}				I _{STM}	
			Breakover Voltage		Break-over Current	Peak Pulse Current T _J ≤ 150°C (5) (10)				Peak One Cycle (Sinusoidal) Surge Current (14)	
			Volts			Amps					
			MIN	MAX	MIN	MAX	MAX	MAX	MAX	MAX	60Hz
S		P0300SA	27	36	10		100	50	50	30	25
		P0640SA	58	70	10		150	75	75	30	25
		P0641SA (16)	58	70	10		150	75	75	30	25
		P0720SA	65	80	10		150	75	75	30	25
		P0800SA	75	95	10		150	75	75	30	25
		P1100SA	90	125	10		100	50	50	30	25
		P1300SA	120	145	10		100	50	50	30	25
		P1500SA	140	170	10		100	50	50	30	25
		P2300SA (11)	190	265	10		100	50	50	30	25
		P2600SA (11)	220	300	10		100	50	50	30	25
		P3100SA (11)	275	350	10		100	50	50	30	25
		P3500SA (11)	300	400	10		100	50	50	30	25
		P2300SB (11)	190	265	10		150	100	100	60	50
		P2600SB (11)	220	300	10		150	100	100	60	50
		P3100SB (11)	275	350	10		150	100	100	60	50
		P3500SB (11)	300	400	10		150	100	100	60	50
		P1500SC (11)	140	170	10	500	200	100	100	60	50

DO-214 Part Numbers and Part Markings

Standardized Part Number	Symbolized Part Number
P0300SA	P03A
P0640SA	P06A
P0641SA	P61A
P0720SA	P07A
P0800SA	P08A
P1300SA	P13A
P1500SA	P15A
P1500SC	P15C
P2300SA	P23A
P2300SB	P23B
P2600SA	P26A
P2600SB	P26B
P3100SA	P31B
P3100SB	P31B
P3500SA	P35A
P3500SB	P35B

NOTE: On the DO-214 package, Date Code is located below the Symbolized Part Number. TO-92 and TO-220 devices have full part numbers and a Date Code printed on the part.

Notes To Electrical Specifications

1. See Figure 4. for V_{BO} change vs. junction temperature.
2. See Figure 2. For I_H vs case temperature.
3. All devices have a negative resistance slope unless otherwise noted. Negative resistance slope devices V_{BO} is measured at an applied rate-of-rise of voltage ≤ 1 kV/Sec. See Figure 3A for V-I characteristics.
4. Capacitance imbalance between forward and reverse polarities is typically ≤ 15 pF.
5. See Figure 1 (A, B, C) for Pulse Wave Form.
6. Maximum T_C is 110°C for TO-92 and 115°C for modified TO-220, except maximum T_C is 75°C for P0300SA, P0300EA70 and 95°C for P0602AA.
7. During simultaneous surging of pins 1 & 3, the current rating of Pin 2 doubles (2X).
8. Between Pins 2 to 1 and Pins 2 to 3.
9. Between any two pins.

Electrical Specifications

I_T	I_H	V_F	V_T	C_O		di/dt
Continuous On-State DC or RMS Current (6)(15)	Holding Current (2)	Forward Voltage Drop	Peak On-State Voltage $I_T = 1$ Amp (17)	Off-State Capacitance at 1kHz 1VAC with 50VDC Bias (4)	Off-State Capacitance at 15mVAC with 50VDC Bias (4)	Critical Rate of Rise of On-State Current
Amps	mAmps	Volts	Volts	pF	pF	Amps/ μ s
MAX	MIN		MAX	TYP	TYP	MAX
1.0	50		5.0	90	90	100
1.0	150		5.0	70	70	100
1.0	150	5.0	5.0	40	113	100
1.0	150		5.0	70	70	100
1.0	150		5.0	70	70	100
1.0	150		5.0	50	50	100
1.0	150		5.0	45	45	100
1.0	150		5.0	35	35	100
1.0	150		5.0	50	50	100
1.0	150		5.0	40	40	100
1.0	150		5.0	40	40	100
1.0	150		5.0	40	40	100
1.0	150		5.0	50	50	100
1.0	150		5.0	40	40	100
1.0	150		5.0	40	40	100
1.0	150		5.0	40	40	100
1.0	200		5.0	42	40	100

10. The current wave virtual front duration is 1.25X rise time from 10% to 90% of crest. Virtual zero is defined as the intersection with zero axis of a straight line drawn through points on the front of the current wave of 10% and 90% crest. Waveforms defined per IEEE/ANSI C62.1.

11. See Figure 3B for V-I characteristics.

12. 260mA minimum I_H is available from the factory on special request.

13. The UL497B rate-of-rise of voltage requirements for V_{B0} testing is 100V/s, 100V/ μ s, 500V/ μ s, and 1kV/ μ s. All SIDACTors V_{B0} 's to be $\pm 10\%$ of ratings.

14. For more than one full cycle rating, see Figure 7.

15. Thermal Resistance:

PxxxSA	DO214-AA	$R_{\theta JC} = 28^\circ\text{C/Watt}$ and $R_{\theta JA} = 90^\circ\text{C/Watt}$
PxxxSB	DO214-AA	$R_{\theta JC} = 26^\circ\text{C/Watt}$ and $R_{\theta JA} = 85^\circ\text{C/Watt}$
PxxxEA70	TO-92	$R_{\theta JC} = 28^\circ\text{C/Watt}$ and $R_{\theta JA} = 90^\circ\text{C/Watt}$
PxxxBA70	TO-92	$R_{\theta JC} = 26^\circ\text{C/Watt}$ and $R_{\theta JA} = 85^\circ\text{C/Watt}$
PxxxAA	TO-220	$R_{\theta JC} = 12^\circ\text{C/Watt}$ and $R_{\theta JA} = 50^\circ\text{C/Watt}$
PxxxAB	TO-220	$R_{\theta JC} = 12^\circ\text{C/Watt}$ and $R_{\theta JA} = 50^\circ\text{C/Watt}$

16. See Figure 3C for V-I characteristics.

17. See Figure 5.

18. See Figure 6.

Electrical Specifications

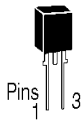
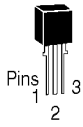
Package Type	Package	Part Number	V _{BO}				I _{BO} Break-over Current μAmps	I _{PP}				I _{TSM}		
			Breakover Voltage (Instantaneous Clamping Voltage) (1)(3)(13)					MAX	Peak Pulse Current T _J ≤ 150°C (5) (10)				Peak One Cycle (Sinusoidal) Surge Current (14)	
			Volts						Amps				Amps	
			PINS 1 to 3		PINS 3 to 2 1 to 2				2x10 μs (7)	10x160 μs (7)	10x560 μs (7)	10x1000 μs (7)	60Hz	50Hz
MIN	MAX	MIN	MAX	MIN	MAX	MAX	MAX	60Hz	50Hz					
A TYPE 61		P2000AA61	190	215			10		100	50	50	30	25	
		P2200AA61	205	230			10		100	50	50	30	25	
		P2400AA61	220	250			10		100	50	50	30	25	
		P2500AA61	240	280			10		100	50	50	30	25	
		P3000AA61	270	330			10		100	50	50	30	25	
		P3300AA61	300	360			10		100	50	50	30	25	
A		P0602AA	54	72	27	36	10		100	50	50	30	25	
		P1602AA	120	190	60	95	10		100	50	50	30	25	
		P2202AA	190	250	95	125	10		100	50	50	30	25	
		P2702AA	240	300	120	150	10		100	50	50	30	25	
		P3002AA	280	320	140	160	10		100	50	50	30	25	
		P4802AA (11)	440	580	220	290	10		100	50	50	30	25	
		P6002AA (11)	540	720	270	360	10		100	50	50	30	25	
		P1602AB	120	190	60	95	10		150	100	100	60	50	
		P2202AB	190	250	95	125	10		150	100	100	60	50	
		P2702AB	240	300	120	150	10		150	100	100	60	50	
		P3002AB	280	320	140	160	10		150	100	100	60	50	
		P4802AB(11)	440	580	220	290	10		150	100	100	60	50	
		P6002AB(11)	540	720	270	360	10		150	100	100	60	50	
		P1553AA	140	170	140	170	10		100	50	50	30	25	
		P2103AA	180	240	180	240	10		100	50	50	30	25	
		P2353AA	210	265	210	265	10		100	50	50	30	25	
		P2703AA	240	300	240	300	10		100	50	50	30	25	
		P3203AA	280	350	280	350	10		100	50	50	30	25	
		P3403AA	300	380	300	380	10		100	50	50	30	25	
		P1553AB	140	170	140	170	10		150	100	100	60	50	
		P2103AB	180	340	180	240	10		150	100	100	60	50	
		P2353AB	210	265	210	265	10		150	100	100	60	50	
		P2703AB	240	300	240	300	10		150	100	100	60	50	
		P3203AB	280	350	280	350	10		150	100	100	60	50	
		P3403AB	300	380	300	380	10		150	100	100	60	50	
		P3002AC	270	330	135	165	10	500	200	100	150	60	50	
		P3202AC	280	350	280	350	10	500	200	100	150	60	50	

Electrical Specifications

I_T	I_H	V_T		C_o				di/dt
Continuous On-State DC or RMS Current (6) Amps	Holding Current (2) (9) mAmps	Peak On-State Voltage $I_T=1\text{Amp}$ (18) Volts		Off-State Capacitance at 1kHz 1VAC with 50 VDC Bias (4) pF		Off-State Capacitance at 1MHz 15mVAC with 50 VDC Bias (4) pF		Critical Rate of Rise of On-State Current Amps/ μ S
		PINS 3 to 2 1 to 2	PINS 1 to 3	PINS 3 to 2 1 to 2	PINS 1 to 3	PINS 3 to 2 1 to 2	PINS 1 to 3	
MAX	MIN	MAX	MAX			TYP	TYP	MAX
1.0	150		10.0		30		30	100
1.0	150		10.0		30		30	100
1.0	150		10.0		30		30	100
1.0	150		10.0		30		30	100
1.0	150		10.0		25		25	100
1.0	150		10.0		25		25	100
1.0	50	5.0	10.0	90	45	90	45	100
1.0	150	5.0	10.0	140	85	140	85	100
1.0	150	5.0	10.0	50	30	50	30	100
1.0	150	5.0	10.0	45	30	45	30	100
1.0	150	5.0	10.0	40	25	40	25	100
1.0	200 (12)	5.0	10.0	50	35	50	35	100
1.0	200 (12)	5.0	10.0	50	30	50	30	100
1.0	200 (12)	5.0	10.0	140	85	140	85	100
1.0	200 (12)	5.0	10.0	90	60	90	60	100
1.0	200 (12)	5.0	10.0	80	50	80	50	100
1.0	200 (12)	5.0	10.0	75	45	75	45	100
1.0	200 (12)	5.0	10.0	50	35	50	35	100
1.0	200 (12)	5.0	10.0	50	30	50	30	100
1.0	150	10.0	10.0	50	40	50	40	100
1.0	150	10.0	10.0	45	35	45	35	100
1.0	150	10.0	10.0	40	30	40	30	100
1.0	150	10.0	10.0	35	25	35	25	100
1.0	150	10.0	10.0	50	40	50	40	100
1.0	150	10.0	10.0	50	40	50	40	100
1.0	200 (12)	10.0	10.0	100	80	100	80	100
1.0	200 (12)	10.0	10.0	80	60	80	60	100
1.0	200 (12)	10.0	10.0	70	55	70	55	100
1.0	200 (12)	10.0	10.0	60	50	60	50	100
1.0	200 (12)	10.0	10.0	50	40	50	40	100
1.0	200 (12)	10.0	10.0	50	40	50	40	100
1.0	200 (12)	5.0	10.0	45	30	45	30	100
1.0	200 (12)	5.0	10.0	40	30	40	30	100

Electrical Specifications

Figure 1A - Pulse Wave Form (10 x 1000 μ s)

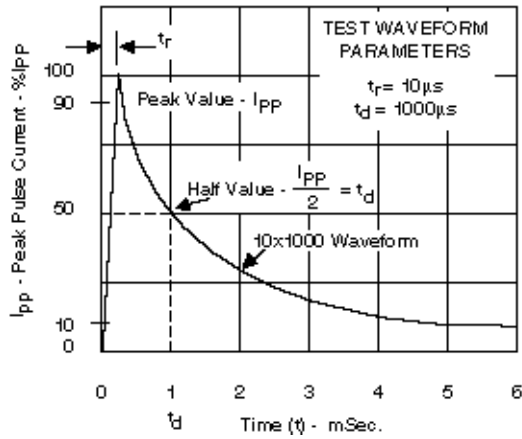

Figure 1B - Pulse Wave Form (10 x 560 μ s)

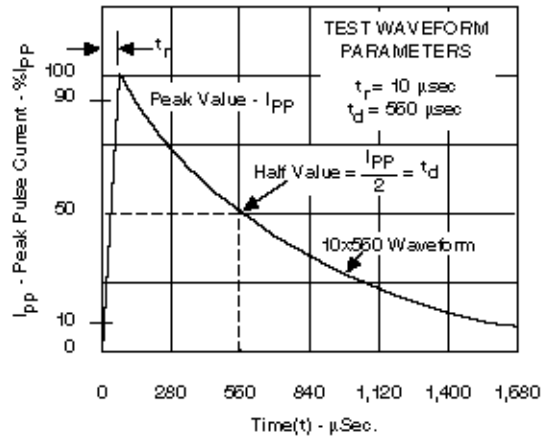

Figure 1C - Pulse Wave Form (10 x 160 μ s)

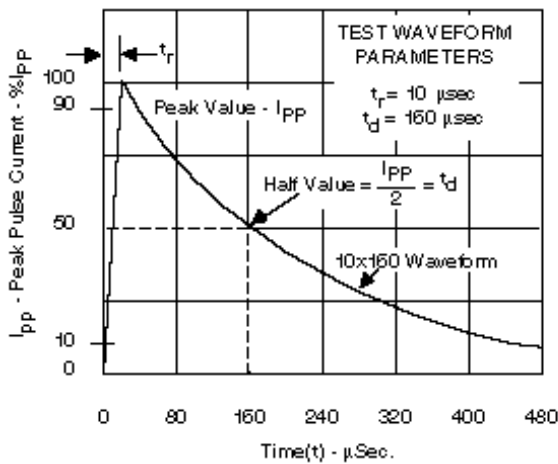

Figure 2 - Normalized DC holding Current vs Case Temperature

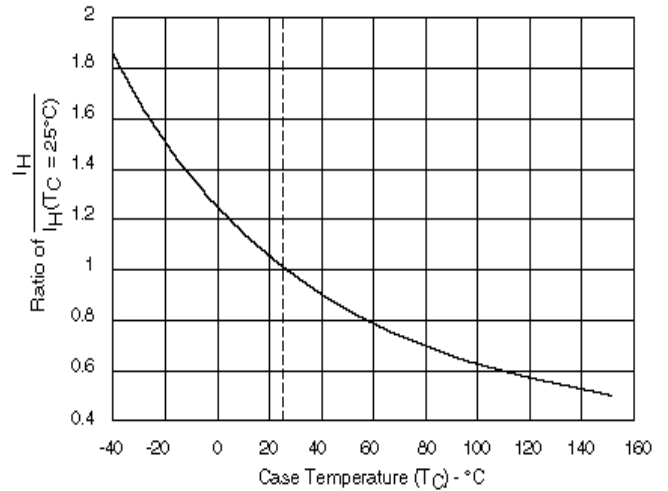

Figure 3A - V-I Characteristics of Devices with Negative Resistance

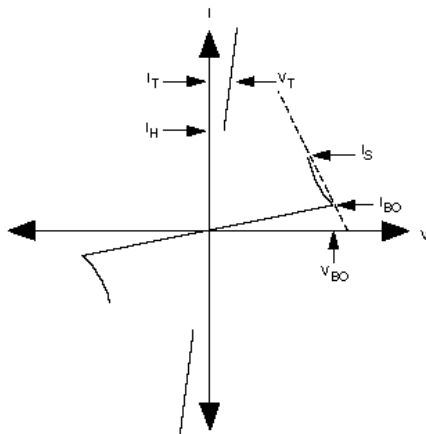
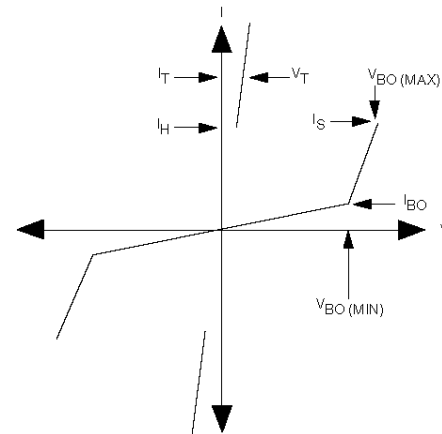

Figure 3B - V-I Characteristics of Devices with Positive Switching Slopes



Electrical Specifications

Figure 3C - V-I Characteristics of devices with a Forward Diode and Reverse Negative Resistance

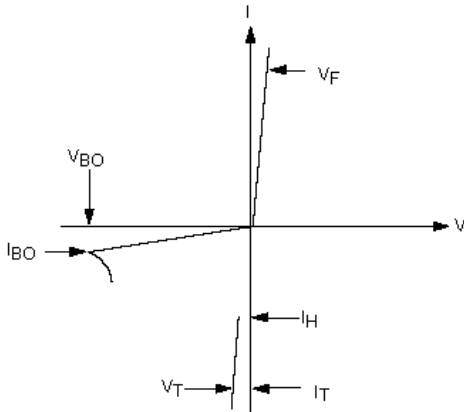

Figure 4 - Normalized V_{BO} Change vs Junction Temperature

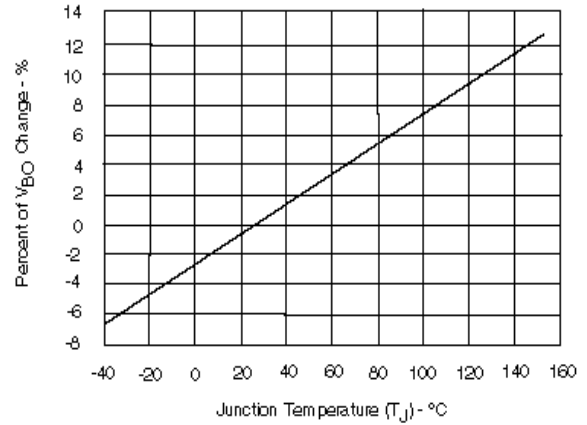

Figure 5 - Peak On-State Voltage vs Peak On-State Current for DO-214AA and TO-92 (Typical)

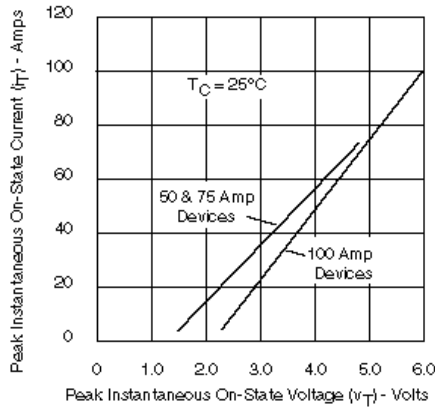

Figure 6 - Peak On-State Voltage vs Peak On-State Current for Modified T0-220, Pins 1 to 3 (Typical)

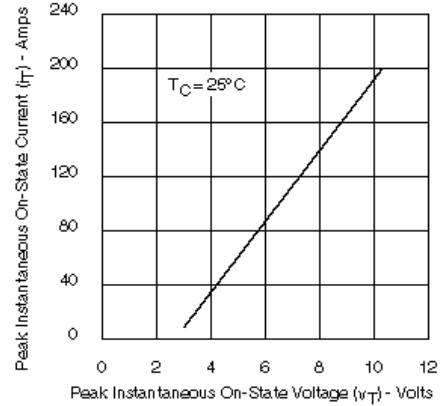
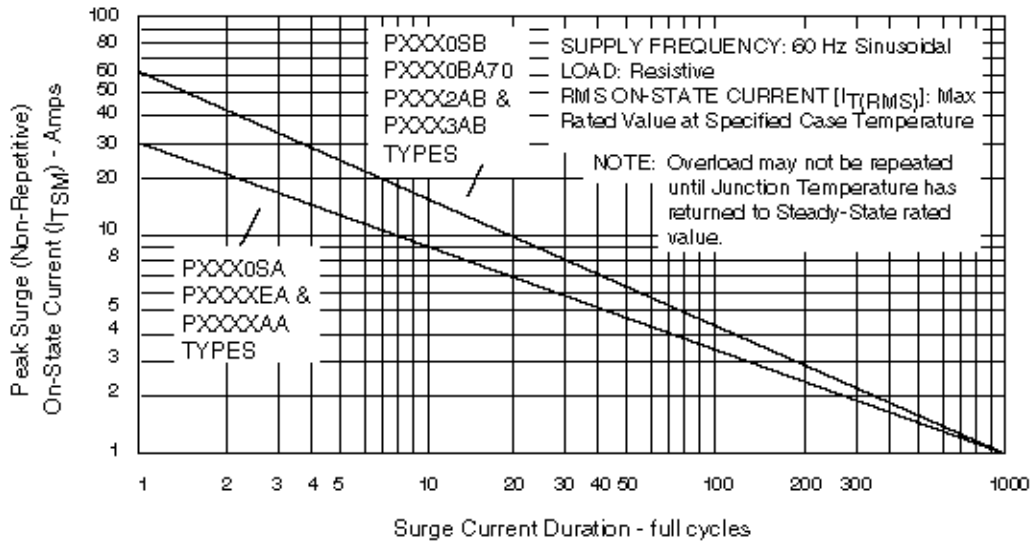

Figure 7 - Peak Surge On-State Current vs Surge Current Duration



Electrical Specifications