

Features

- * LOW CURRENT REQUIREMENTS
- * HIGH LIGHT OUTPUT
- * RELIABLE AND RUGGED
- * IC COMPATIBLE

Absolute Maximum Ratings at T_A=25°C

REVERSE VOLTAGE	GaAsP RED 3.0 V, OTHER 5.0 V
D.C. FORWARD CURRENT	30 mA
PULSE CURRENT (1/10 DUTY CYCLE, 0.1 ms PULSE WIDTH)	100 mA
OPERATING TEMPERATURE RANGE	-25°C TO +85°C
STORAGE TEMPERATURE RANGE	-25°C TO +100°C
LEAD SOLDERING TEMP. (1.6mm FROM BODY)	260°C FOR 5 SEC

Electrical/Optical Characteristics at T_A=25°C

PART NUMBER	LED CHIP		LEN'S COLOR		PEAK WAVELENGTH @20mA(nm)	FORWARD VOLTAGE @20mA(V)		LUMINOUS INTENSITY @20mA(mcd)		VIEW ANGLE 2θ _{1/2} (deg)	
	MATERIAL	EMITTING COLOR				TYP.	MAX.	MIN.	TYP.		
LT0311-41	LT0312-41	GaAsP	RED	R.D.	W.D.	655	1.7	2.0	1.1	1.8	56
LT0311G-41	LT0312G-41	GaP	RED	R.D.	W.D.	700	2.1	3.0	1.6	2.7	56
LT0321-41	LT0322-41	GaP	GREEN	G.D.	W.D.	567	2.1	3.0	8.0	13.3	56
LT0331-41	LT0332-41	GaAsP ON GaP	YELLOW	Y.D.	W.D.	585	2.1	3.0	6.6	11.0	56
LT0341-41	LT0342-41	GaAsP ON GaP	ORANGE	O.D.	W.D.	635	2.1	3.0	9.3	15.5	56
LT0341R-41		GaAsP ON GaP	ORANGE	R.D.		635	2.1	3.0	9.3	15.5	56
LT0313-41	LT0314-41	GaAsP	RED	W.C.	R.C.	655	1.7	2.0	3.7	6.1	36
LT0313G-41	LT0314G-41	GaP	RED	W.C.	R.C.	700	2.1	3.0	5.5	9.2	36
LT0323-41	LT0324-41	GaP	GREEN	W.C.	G.C.	567	2.1	3.0	27.0	45.0	36
LT0333-41	LT0334-41	GaAsP ON GaP	YELLOW	W.C.	Y.C.	585	2.1	3.0	22.6	37.6	36
LT0343-41	LT0344-41	GaAsP ON GaP	ORANGE	W.C.	O.C.	635	2.1	3.0	31.7	52.9	36
	LT0344R-41	GaAsP ON GaP	ORANGE		R.C.	635	2.1	3.0	31.7	52.9	36

- (1) LENS COLOR G.D. GREEN DIFFUSED Y.C. YELLOW CLEAR (2) SPECIFICATIONS ARE SUBJECT TO CHANGE WITHOUT NOTICE.
R.D. RED DIFFUSED O.D. ORANGE DIFFUSED G.C. GREEN CLEAR (3) ALL ABOVE COMPONENTS ARE CONSIDERED. DEVIATIONS FROM STATED SPECIFICATIONS WILL REQUIRE A NEW PART NUMBER BE ASSIGNED.
Y.D. YELLOW DIFFUSED W.C. WATER CLEAR O.C. ORANGE CLEAR
W.D. WHITE DIFFUSED R.C. RED CLEAR

Package Dimensions

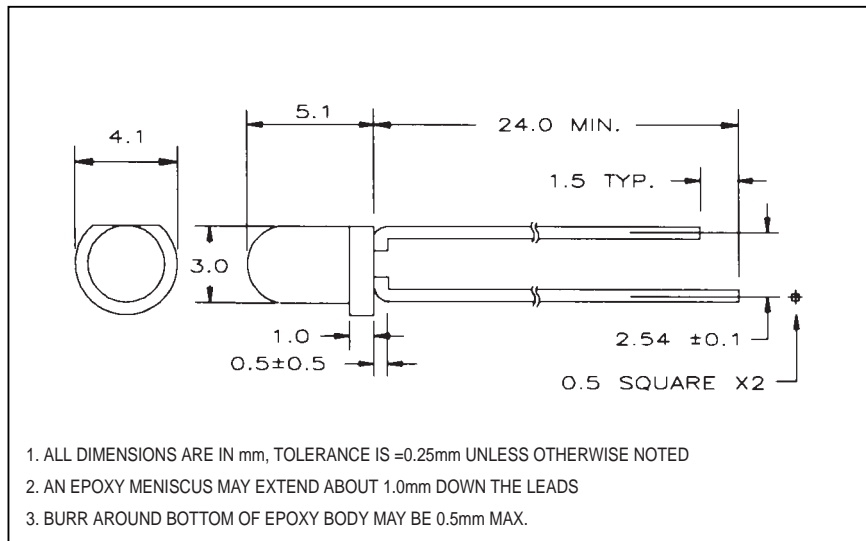

Radiation Pattern

